

# Medical AC-DC Open Frame Power Supply

## 24V/400W 3"x5" High Density MDS-400APB24 AA

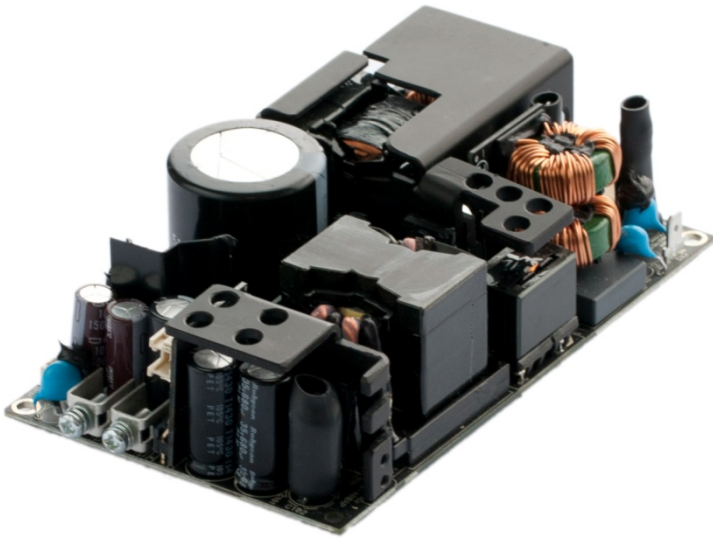

# MDS-400APB24 AA

## Highlights & Features

- Safety Approvals to IEC 60601-1 3.1rd ed. & IEC 60950-1
- Compliant with IEC 60601-1-2 4th Ed. Requirements
- Up to 200W convection, 400W force air
- IT & Medical Safety Approvals

## Safety Standards



CB Certified for worldwide use

**Model Number:** MDS-400APB24 AA  
**Unit Weight:** 405g  
**Dimensions (W x L x H):** 76.2x127x35.6mm  
 3x5x1.4 inch

## General Description

The MDS-400APB24 of internal open frame power supplies come with universal AC input range from 90Vac to 264Vac. Other features include low leakage, Type BF Patient Access Leakage Currents, and electric shock protection compliance with 2 x MOPP requirements. The MDS series is certified for EMC standards according to EN 55011 for industrial, scientific and medical (ISM) radio-frequency equipment; and, EN 55022 for Industrial Technology Equipment (ITE) radio-frequency equipment. In addition, only recognized Japanese capacitors are used to ensure long product life.

The MDS-400A series comes with both medical and ITE safety approvals, including UL/CE/CCC (5000meters), and CB certification. Designs are compliant with RoHS Directive 2011/65/EU for environmental protection.

## Model Information

### Medical AC-DC Open Frame

Model Number	Main Output Voltage	Main Output Current	Standby Output Voltage	Standby Output Current	Fan Output Voltage	Fan Output Current	Total Max Output Power
MDS-400APB24 AA	24Vdc	0-16.66A	5Vdc	0-2A	12Vdc	0.05-0.6A <sup>1)</sup>	400W <sup>2)</sup>

1) Fan output will be presenting when 24V main output is available

2)With 10CFM force air

## Model Numbering

<b>MDS</b> Delta Medical power Supply	<b>400</b> Max wattage in the product Series. Maybe lower at some voltage. 060 → 60W 150 → 150W 1K2 → 1,200W	<b>A</b> Family Code A ~ Z	<b>P</b> Product Type P: Open Frame	<b>B</b> Input Type Code B: 3pin Classl	<b>24</b> Output Voltage 24 for 24V	<b>A</b> Revision Code	<b>A</b> Revision code
--	---	----------------------------------	---	---	---	---------------------------	---------------------------

# Medical AC-DC Open Frame Power Supply

## 24V/400W 3"x5" High Density MDS-400APB24 AA

### Specifications

#### Input Ratings / Characteristics

Nominal Input Voltage	100-240Vac
Input Voltage Range	90-264Vac
Nominal Input Frequency	50-60Hz
Input Frequency Range	47-63Hz
Input Current (max)	5.5A
Input Surge Voltage (max)	300Vac for 100ms
Full load Efficiency (typ.)	92% @ 115Vac/60Hz 93% @ 230Vac/50Hz, Reference Fig.1
Standby Power (max)	0.5W (only standby working with Inhibit signal high) @ 115Vac/60Hz, 230Vac/50Hz
Inrush Current (max)	40A@230Vac, cold start
Input-PE(protective earth) leakage current(max)	0.1mA @ NC, 0.3mA @ SFC1)
Output-PE(protective earth) leakage current for Type BF application (max)	0.1mA @ NC, 0.5mA @ SFC 1)
Power Factor (min)	0.95 @ 115V/50Hz, 230V/50Hz, full load

1) NC: normal condition, SFC: single fault condition

#### Leakage Current

Input-PE Leakage Current	100Vac/60Hz(Typ)	264Vac/60Hz(Typ)	Delta Limit	IEC60601-1 Limit
Normal Condition	18.3uA	44.6uA	100uA max	5000uA max
Single Fault Condition	33.7uA	91.9uA	300uA max	10000uA max
Output-PE Leakage Current for Type BF application				
Normal Condition	29.4uA	87.3uA	100uA max	100uA max
Single Fault Condition	43.5uA	130.5uA	500uA max	500uA max

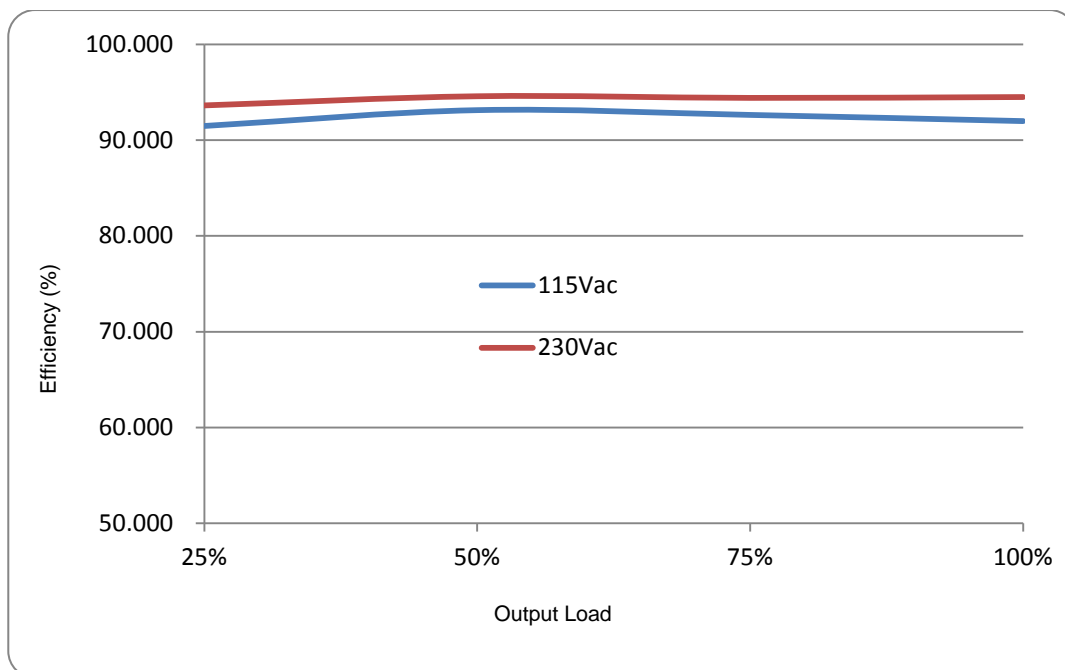

Fig.1 Efficiency versus output load

# Medical AC-DC Open Frame Power Supply

## 24V/400W 3"x5" High Density MDS-400APB24 AA

### Output Ratings / Characteristics

Nominal Output Voltage (Vrated)	24V
Output Voltage Tolerance	±3%
Output Power	400W max with 10CFM air cooling
Line Regulation (max)	±0.5%
Load Regulation (max)	±1%
Ripple & Noise (typ.)	1%pk-pkVrated@ Full load, Reference Fig. 2
Start-up Time(max)	2000ms@115Vac
Hold-up Time (min)	10ms@115Vac, with 400W load
Dynamic Response (Overshoot & Undershoot O/P Voltage)	±5% @50-100% load
Capacitive load (max)	1500uF
Rise time (max)	100ms
Remote Sense	Compensate up to 500mV lead drop with remote sense Short and reverse connection protected. PSU can work normally with remote sense pins left open.

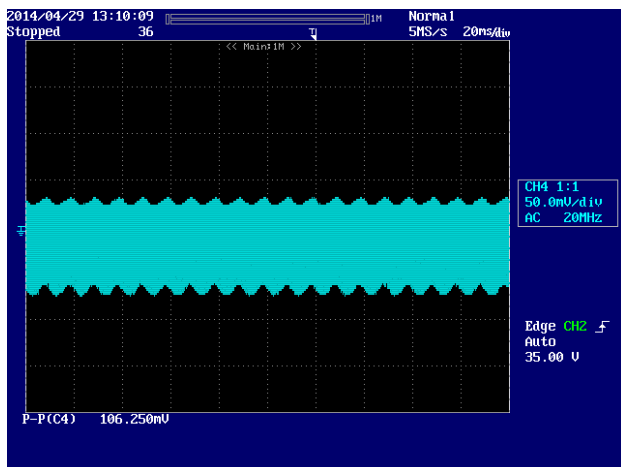

(a) 115V (measured value=106mV)

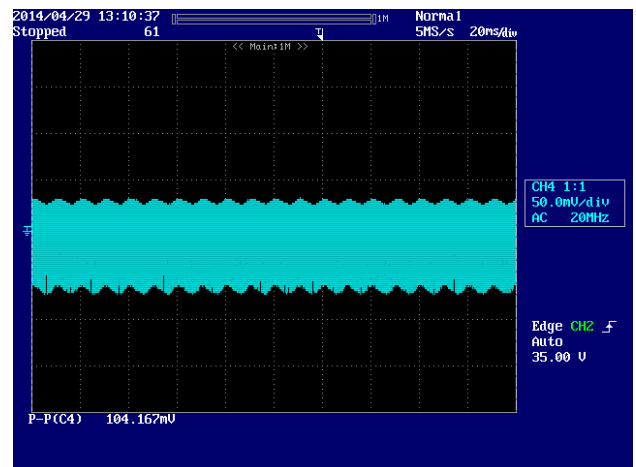

(b) 230V (measured value=104mV)

Fig.2 Ripple & Noise example, 20MHz BW

### Ripple & Noise measurement circuit

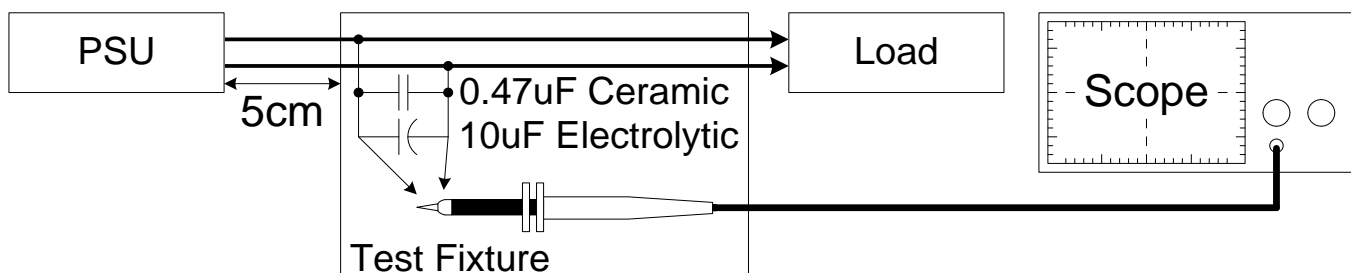

# Medical AC-DC Open Frame Power Supply

## 24V/400W 3"x5" High Density MDS-400APB24 AA

### Mechanical

Case Cover	NA
Dimensions (W x L x H typ.)	76.2x127x35.6mm (3x5x1.4inch)
Unit Weight	405g
Indicator	NA
Cooling System	NA

### Environment

Surrounding Air Temperature	Operating	Absolute Max -10°C to+70°C, supported power linearly de-rate from 50°C to 50% rated up to 70°C for forced air. Convection power de-rate from 200W @ 40°C to 100W @ 60°C Note: see power de-rating curve
	Storage	-40°C to+85°C
Operating Humidity		5-95% RH (Non-Condensing)
Operating Altitude		5,000 meters(16402 fts)
Shock Test (Non-Operating)		50G, 11ms, 3 shocks for each direction
Vibration (Operating)		5-500Hz, 2Grms, 15 minute for each three axis

# Medical AC-DC Open Frame Power Supply

## 24V/400W 3"x5" High Density MDS-400APB24 AA

Power De-rating curve

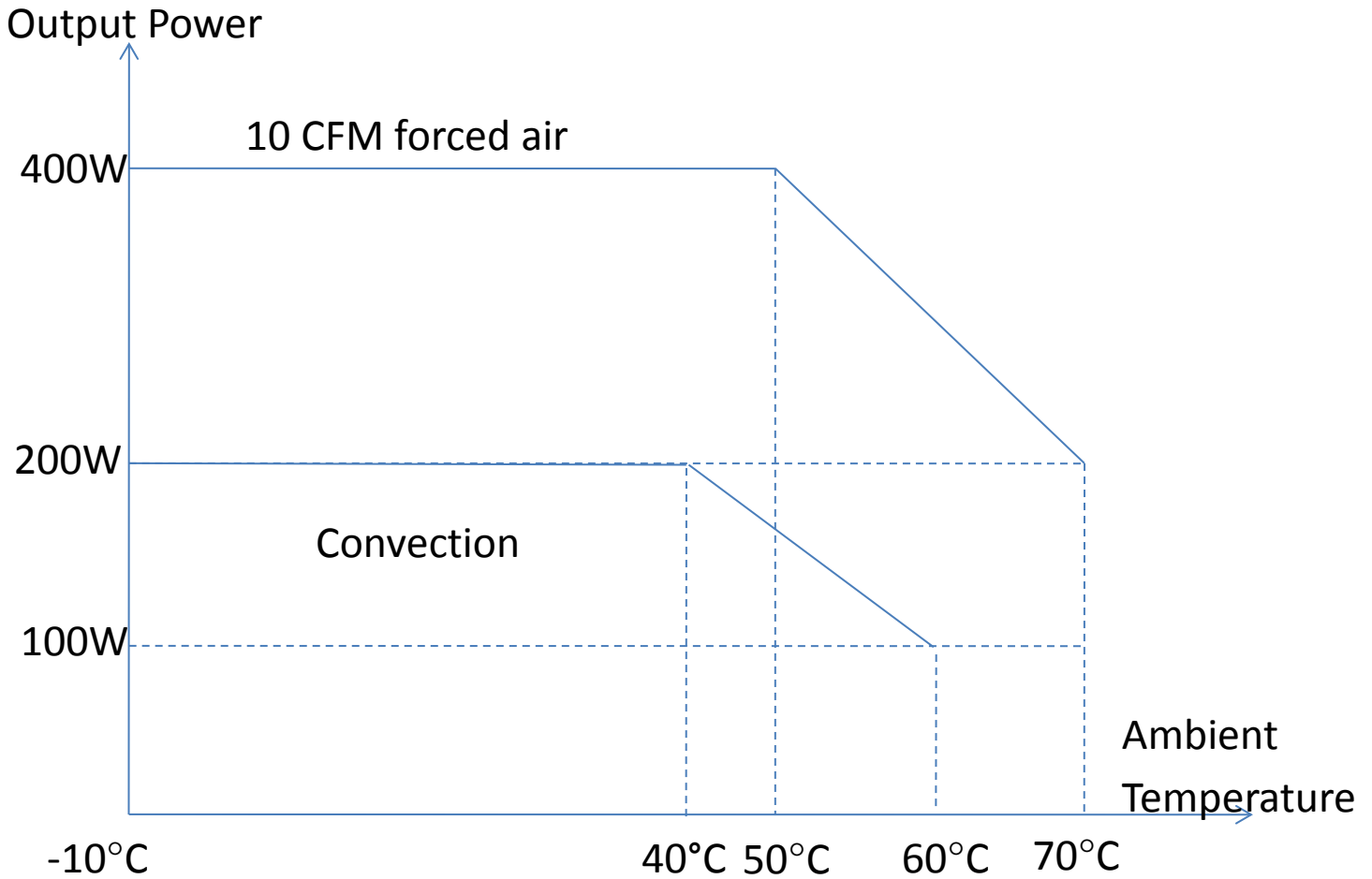

# Medical AC-DC Open Frame Power Supply

## 24V/400W 3"x5" High Density MDS-400APB24 AA

### Protections

Overvoltage (max)	135% of rated voltage, Latch Mode
Overload / Overcurrent (max)	Main output 160% of rated current Standby 3A max Hiccup Mode(Non-Latching, Auto-Recovery)
Over Temperature	Latch Mode
Short Circuit	Hiccup Mode, (Non-Latching, Auto-Recovery)

### Reliability

MTBF(Minimum) at 115Vac, 400W, 35°C, 10CFM Air Flow	500 kHrs based on Telecordia SR-332
Operating life at 115Vac, 400W, ambient 25 °C, 10CFM Air Flow	26,280Hrs

### Safety Standards / Directives

Medical Safety	IEC60601-12 <sup>nd</sup> and 3 <sup>rd</sup> , and 3 <sup>rd</sup> +A1 edition CB report TUV EN60601-1:2006 UL60601-1+CAN/CSA 60601-1: (Ed.3.2005)
ITE Safety	IEC60950-1 CB report TUV60950-1 UL60950-1+CAN/CSA60950-1 GB4943.1-2011, GB9254-2008, GB17625.1-2003
CE	MDD Directive 93/42/EEC
Environmental	RoHS Directive 2011/65/EU Compliant
Galvanic Isolation	Input to/Output (2XMOPP) 4000 Vac Input to/Ground(1XMOPP) 1500Vac <sup>1)</sup> Output to/Ground(1XMOPP) 1500Vac ( Type BF application rated)

1) PSU can support PoE applications with Primary to FG 2500Vac test.

# Medical AC-DC Open Frame Power Supply

## 24V/400W 3"x5" High Density MDS-400APB24 AA

EMC (Compliant with IEC 60601-1-2 4th Ed. Requirements)

EMC / Emissions		EN55011/EN55022,FCC Title 47:Class B
Harmonic Current Emissions	IEC61000-3-2	Meet Class D limit
Immunity to		
Voltage Flicker	IEC61000-3-3	
Electrostatic Discharge	IEC61000-4-2	Level 4 Criteria A <sup>1)</sup> Air Discharge: 15kV Contact Discharge: 8kV
Radiated Field	IEC61000-4-3	Criteria A <sup>1)</sup> 80MHz-2700MHz, 10V/m AM modulation 385MHz-5785MHz, 28V/m Pulse mode and other modulation
Electrical Fast Transient / Burst	IEC61000-4-4	Level 3 Criteria A <sup>1)</sup> :2kV
Surge	IEC61000-4-5	Level 3 Criteria A <sup>1)</sup> Common Mode <sup>3)</sup> : 2kV Differential Mode <sup>4)</sup> : 1kV
Conducted	IEC61000-4-6	Level 2 Criteria A <sup>1)</sup> 150kHz-80MHz, 3Vrms, 6Vrms at ISM bands and Amateur radio bands
Power Frequency Magnetic Fields	IEC61000-4-8	Criteria A <sup>1)</sup> Magnetic field strength 30A/m
Voltage Dips	IEC61000-4-11	Criteria A <sup>1)</sup> 0% U <sub>r</sub> , 0.5 cycle (10ms) , 0°/45°/90°/135°/180°/225°/270°/315°/360°  Criteria B <sup>2)</sup> 0% U <sub>r</sub> , 1 cycle (20ms), 0°  Criteria B <sup>2)</sup> 70% U <sub>r</sub> , 25 cycle (500ms), 0°  Criteria B <sup>2)</sup> 0% U <sub>r</sub> , 250 cycle (5000ms), 0°

1) Criteria A: Normal performance within the specification limits

2) Criteria B: Output out of regulation, or shuts down during test. Automatically restore to normal operation after test.

3) Asymmetrical: Common mode (Line to earth)

4) Symmetrical: Differential mode (Line to line)

# Medical AC-DC Open Frame Power Supply

## 24V/400W 3"x5" High Density MDS-400APB24 AA

### Dimensions

W x L x H: 76.2 x 127.0 x 35.6 mm

### Mechanical drawing (3Pin input type)

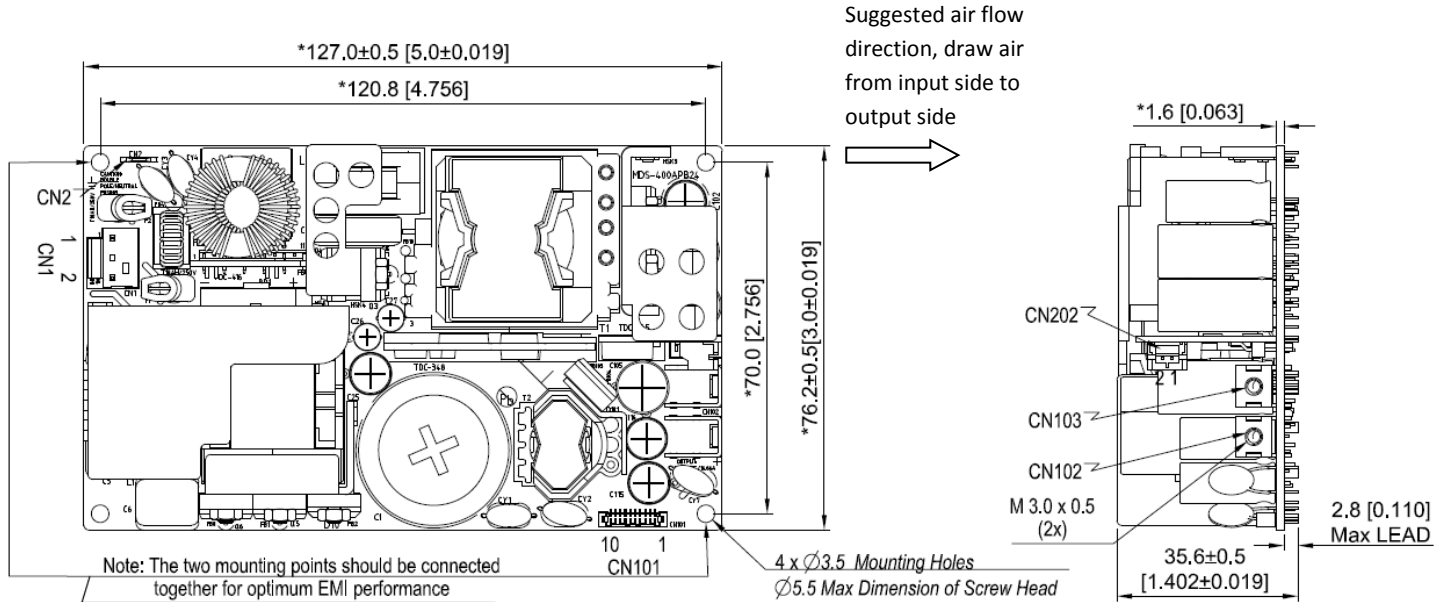

### Notes

—Dimensions are in mm(inches)

Input Connector CN1	
Pin 1	Neutral
Pin 2	Line

CN1 mates with Molex housing 26033031 and Molex series 6838 crimp terminals.

Output Connector	
CN102	Vo
CN103	DC RTN

Fan Connector CN202	
Pin1	DC RTN
Pin2	12V Fan

CN202 mates with JST housing PHR-2 and JST SPH-002T-P0.5S terminals.

Control and STANDBY connector CN101	
Pin 1	Remote sense +
Pin 2	Remote sense -
Pin 3	Power Good +
Pin 4	Power Good -(DC RTN)
Pin 5	Remote ON_OFF/INHIBIT +
Pin 6	Remote ON_OFF/INHIBIT -(DC RTN)
Pin 7	5V Standby
Pin 8	DC RTN
Pin 9	5V Standby
Pin 10	DC RTN

CN101 mates with Molex housing 1041421000 and Molex series 104539 crimp terminals.

Two mounting points in mechanical drawing need to be connected to system earth case together, Protective bonding conductor from the end product protective earth terminal (if any) can be tied to CN2 for open frame model.



# Medical AC-DC Open Frame Power Supply

## 24V/400W 3"x5" High Density MDS-400APB24 AA

### Functions

#### Start-up Time

The time required for the output voltage to reach 90% of its set value, after the input voltage is applied.

#### Rise Time

The time required for the output voltage to change from 10% to 90% of its set value.

#### Hold-up Time

Hold up time is the time when the AC input collapses and output voltage retains regulation for a certain period of time. The time required for the output to reach 90% of its set value, after the input voltage is removed.

### ■ Graph illustrating the Start-up Time, Rise Time, and Hold-up Time

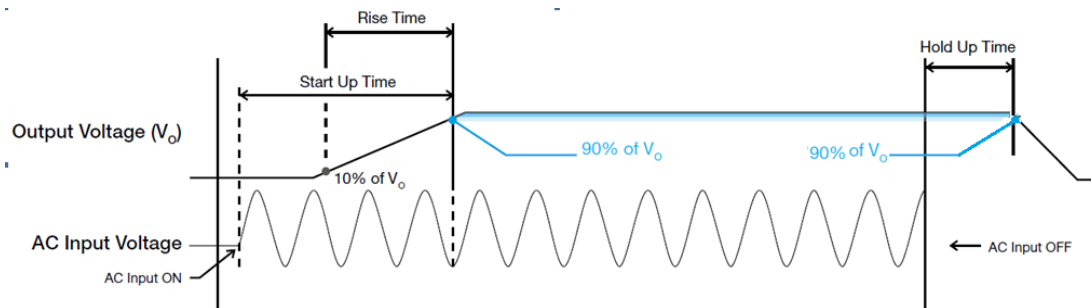

# Medical AC-DC Open Frame Power Supply

## 24V/400W 3"x5" High Density MDS-400APB24 AA

### Dynamic Response

The power supply output voltage will remain within  $\pm 5\%$  of its steady state value, when subjected to a dynamic load 50 to 100% of its rated current.

■ 50 to 100% Load

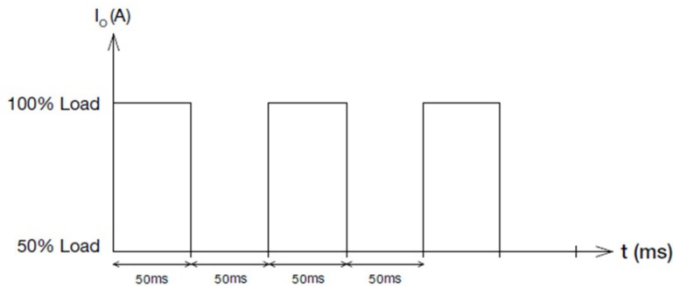

### Inrush Current

Inrush current is the peak, instantaneous, input current measured and, occurs when the input voltage is first applied. For AC input voltages, the maximum peak value of inrush current will occur during the first half cycle of the applied AC voltage. This peak value decreases exponentially during subsequent cycles of AC voltage.

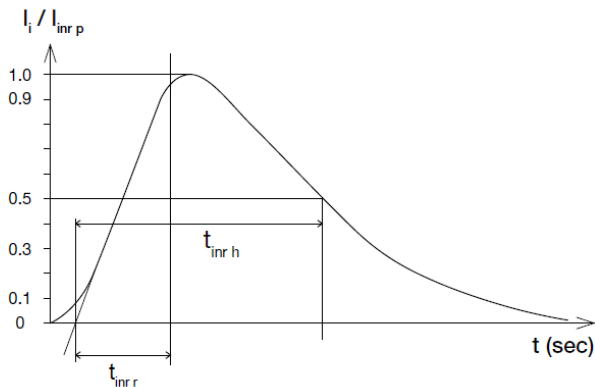

### Overvoltage Protection

The power supply's overvoltage circuit will be activated when its internal feedback circuit fails. The output voltage shall not exceed its specifications defined on Page 4 under "Protections". Power supply will latch off, and require removal/re-application of input AC voltage in order to restart.

### Short Circuit Protection

The power supply's output OLP/OCP function also provides protection against short circuits. When a short circuit is applied, the output current will operate in "Hiccup mode", as shown in the illustration in the OLP/OCP section on this page. The power supply will return to normal operation after the short circuit is removed.

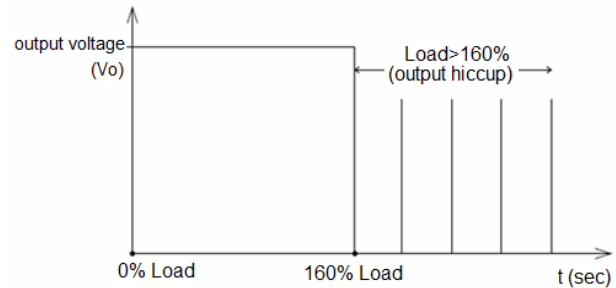

### Overload & Overcurrent Protections

The power supply's Overload (OLP) and Overcurrent (OCP) Protections will be activated before output current under 160% of  $I_o$  (Max load). Upon such occurrence,  $V_o$  will start to drop. Once the power supply has reached its maximum power limit, the protection will be activated and the power supply will go into "Hiccup mode" (Auto-Recovery). The power supply will recover once the fault condition causing the OLP and OCP is removed and  $I_o$  is back within the specified limit.

Additionally, if the load is  $< 160\%$  but  $> 100\%$  for a prolonged period of time (depending on the load), the Over Temperature Protection (OTP) will be activated due to high temperature on critical components. The power supply will then go into latch mode.

### Over Temperature Protection

As mentioned above, the power supply also has Over Temperature Protection (OTP). This is activated when the overload condition persists for an extended duration and the output current is below the overload trigger point but  $> 100\%$  load. In the event of a higher operating temperature condition at 100% load, the power supply will run into OTP when the surrounding air temperature is higher than the operating temperature. When activated, the output voltage will go into latch mode until the input voltage is removed; then, reapplied, and the surrounding air temperature drops to its normal operating temperature.

# Medical AC-DC Open Frame Power Supply

## 24V/400W 3"x5" High Density MDS-400APB24 AA

### Power Good

Power Good+ pin is an open collector transistor (40V/600mA rating). A resistor (suggested value 10Kohm, 1/8W) can be added between 5V STANDBY pin (or, other available pull-up voltage that is no greater than 30V) and the Power Good+ pin (refer to figure below). Value of pull-up resistor may have to be adjusted, depending on voltage used, and other end-use conditions of the Power Good+ pin connection to the product. When AC input is on, Power Good+ pin will be high. When AC input is off, Power Good+ pin will be low. There will be a minimum of 3 milliseconds between the time the power good goes to low level, and the time when the output reaches 90% of its rated value.

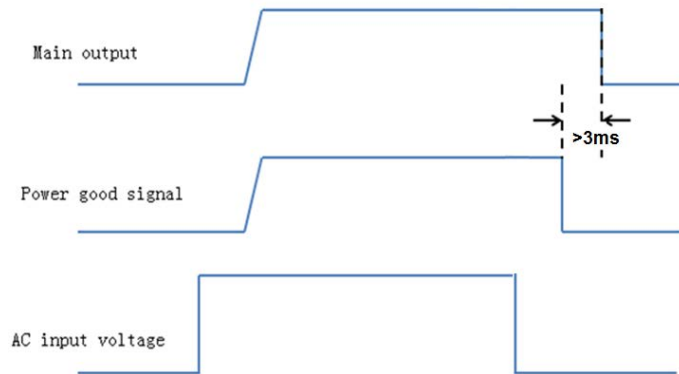
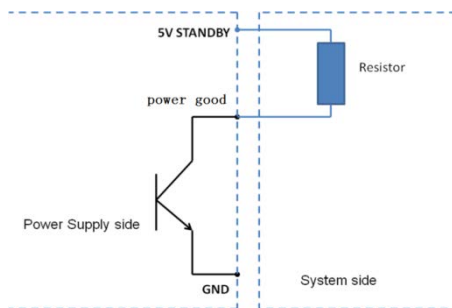

### Remote On\_Off/Inhibit

Remote ON\_OFF/INHIBIT can be used to enable or disable only the main output. When the main output is disabled, the +5V Standby output will continue to operate. This signal can be pulled down to a low level of 0.3 volts, or shorted to DC-Return, in order for the main output to be enabled; and, floated (no connection to the signal), or pulled up to a value greater than or equal to 3 volts, in order to disable the main output.

### Remote Sense

Remote sense feature can be used to compensate for the extra voltage drop on output wires that are connected from the main output terminals, to the load. With wires connected from the remote sense pins, at the same locations as the wires from the main output, the remote sense function can compensate up to 500mV voltage drop. The power supply will not be damaged if the remote sense pins are shorted, or if a reverse/inverted polarity connection is made to the load.

# Medical AC-DC Open Frame Power Supply

## 24V/400W 3"x5" High Density MDS-400APB24 AA

### Certificate



All Delta Medical Power products conform to the European directive 2011/65/EU. RoHS is the abbreviation for "Restriction of the use of certain hazardous substances"



Delta has been certified as meeting the requirement of ISO 13485: 2003 and EN ISO 13485:2012 for the design and manufacture of switching power supply and adaptor for medical device.



In addition to a UL Total Certification Program (TCP) approved client laboratory for IEC60950 and IEC60065. Delta also has participated UL Client Test Data Program (CDTP) for IEC 60601